

## GENERAL DESCRIPTION

The microStar M is a flush mount microwave motion sensor with Human Presence Radar™ (HPR™) for activating all types of automatic doors. The microStar™ M provides unparalleled protection to even the slowest moving pedestrians from doors closing prematurely.

- Fits on 1 3/4" door frames
- Visible LED to verify activation
- Fast install mode lets pattern be set without cycling door
- HPR™ provides additional level of motion detection after initial door activation
- Selectable bi-directional or unidirectional (Approach/Depart)
- Narrow & wide pattern antennas
- Dual axis pattern adjustment (left/right; in/out)



## INSTALLATION PREPARATION



**NOTE:** Remember to follow these safety precautions:

- Shut off power to the automatic door before wiring sensor.
- Always ensure wiring is located clear of any moving door parts to avoid damage.
- Always be aware of pedestrian traffic. Keep people clear of the work area when setting up or testing the door.
- Comply with all applicable building codes and safety standards (ANSI A156.10).

### Sensor Mounting:

1. Remove the cover of the microStar by placing the blade of a small screwdriver in the notch in the right side of the cover as shown **(B)**. Once the sensor is attached to the header always remove the cover in this same manner.

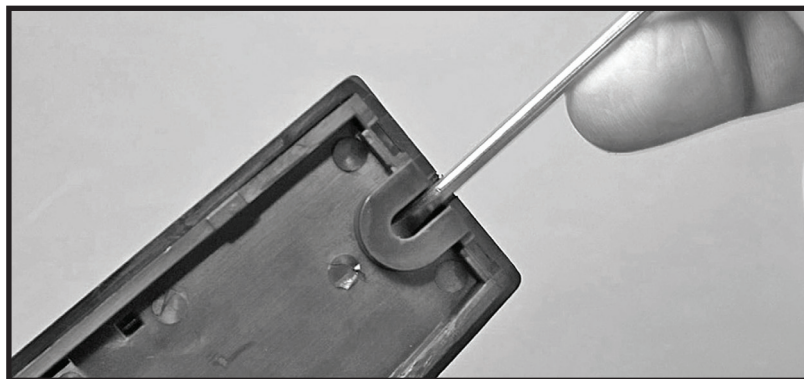

**(B) Insert Small Screwdriver and Pry Upwards**

**INSTALLATION PREPARATION (continued)**

2. Peel and attach the self-sticking mounting template **(C)** at the desired location. Drill 3 holes noted on template (1 wire passage hole, 2 screw pilot holes).

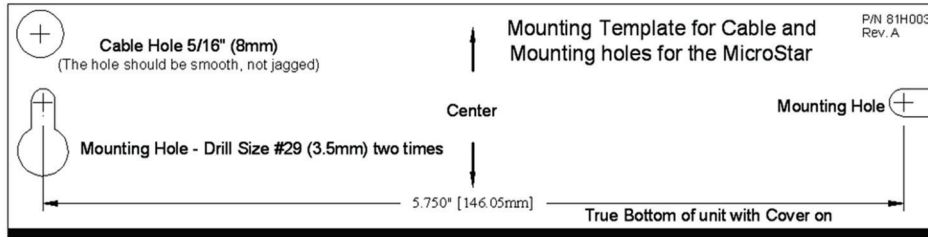

**(C) Mounting Template**

3. Insert mounting screws partially into holes. Route the wire harness through the wire passage hole as shown **(D)**. Install the microStar onto the mounting screws and tighten.

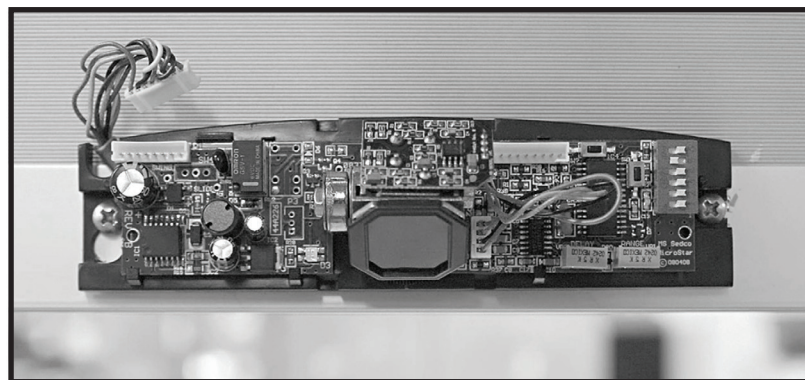
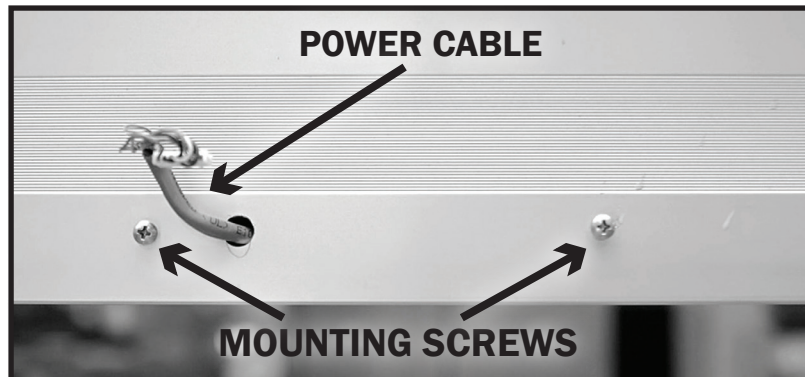

**(D) Wire Harness & Mounted microStar**

## SENSOR WIRING

With power OFF, connect sensor wiring to the operator control as shown (E).

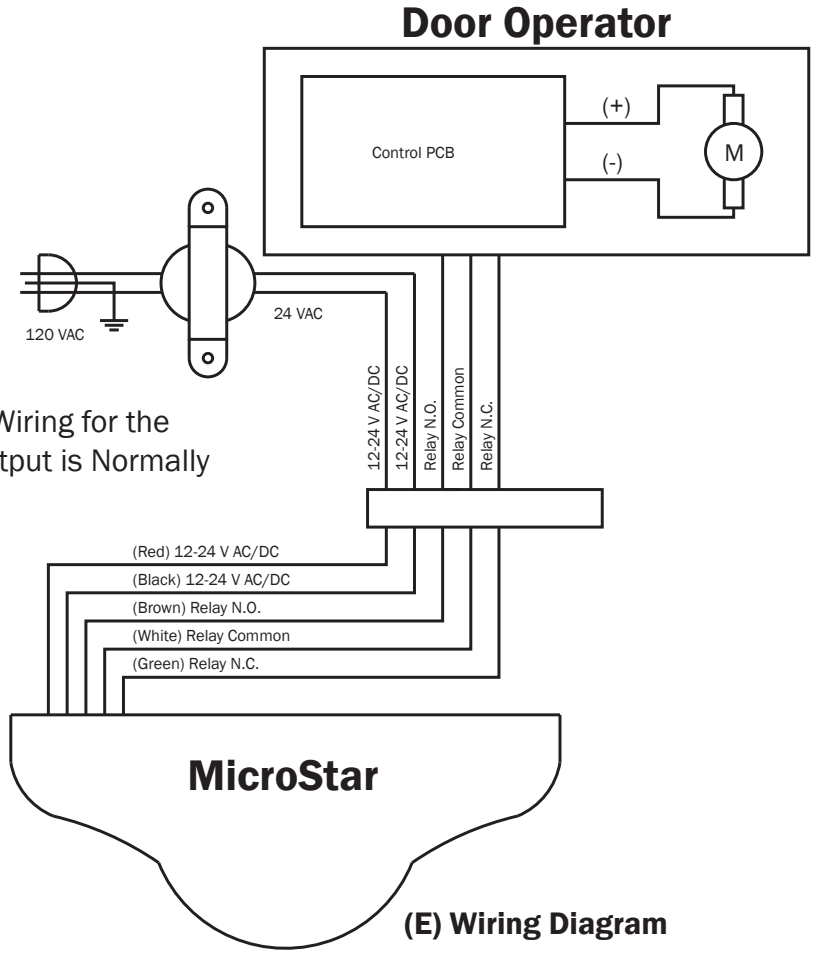

**NOTE:** Typical Wiring for the microStar M output is Normally Open (N.O.).

## SENSOR SETTINGS AND ADJUSTMENTS

All settings and adjustments can be made via the microStar main circuit board as shown (F). There is no need for costly or confusing proprietary set up devices.

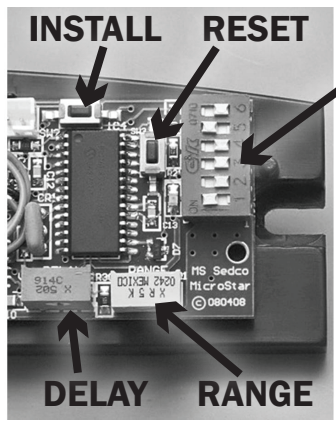

**SWITCH SETTINGS**

LEFT	RIGHT
6. NOT USED	6. NOT USED
5. FAILSAFE OFF	5. FAILSAFE ON
4. HPR OFF	4. HPR ON
3. NOT USED	3. NOT USED
2. DEPART	2. APPROACH
1. BI-DIRECTION	1. UNI-DIRECTION

**(F) Main Circuit Board Picture**

**SENSOR SETTINGS AND ADJUSTMENTS (continued)**

1. Apply power to the unit. Wait until the LED lights solid (Green = no detection; Red = detection).

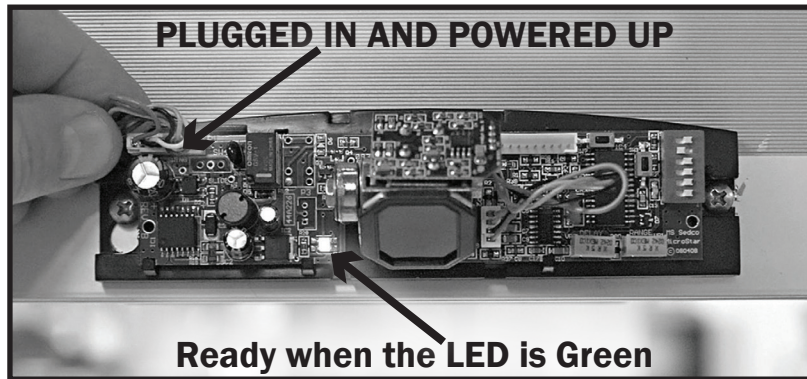

2. Program Dip Switches for desired settings (F).

**Human Presence Radar (HPR):** When dipswitch #4 is **ON** HPR is engaged and provides enhanced motion detection to protect slower moving pedestrians.



**Failsafe:** With the microStar output wired N.O., when dipswitch #5 is **ON** Failsafe is disabled and door will remain closed in the event of power failure. When dipswitch #5 is **OFF**, Failsafe is enabled and the door will open in the event of power failure.

3. Select and install patch antenna as shown (G). The wide antenna is installed at factory



Typically the **Wide antenna** is used on sliding or bifolding automatic doors the **Narrow antenna** is used on swing or revolving automatic door applications.

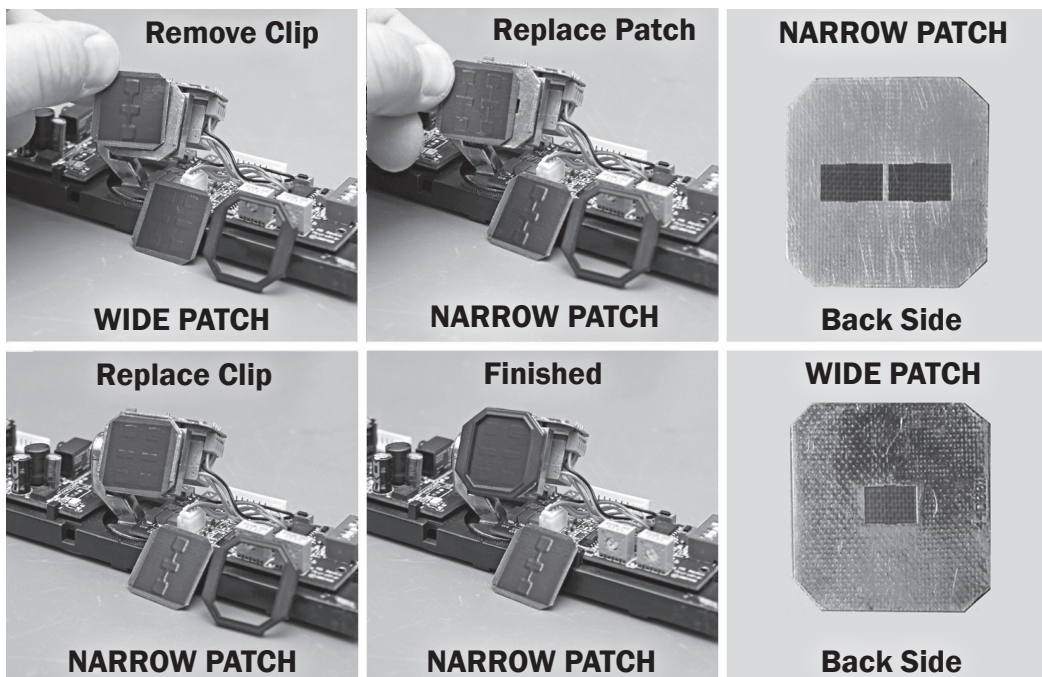

**(G) Installing a Patch Antenna**

**SENSOR SETTINGS AND ADJUSTMENTS (continued)**

- Adjust detection pattern size via the range potentiometer. Pattern location can be manually moved right to left or tilted in and out via the antenna **(H)**.

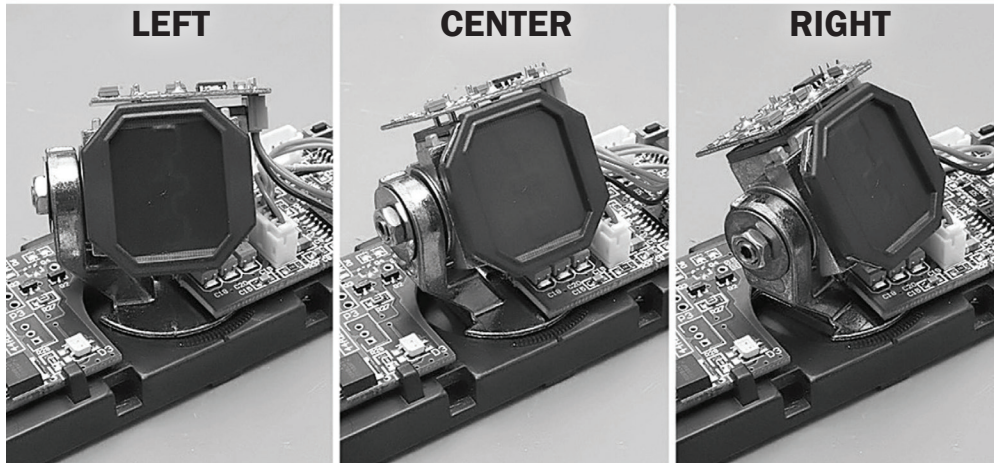

**Adjust the head LEFT to RIGHT**

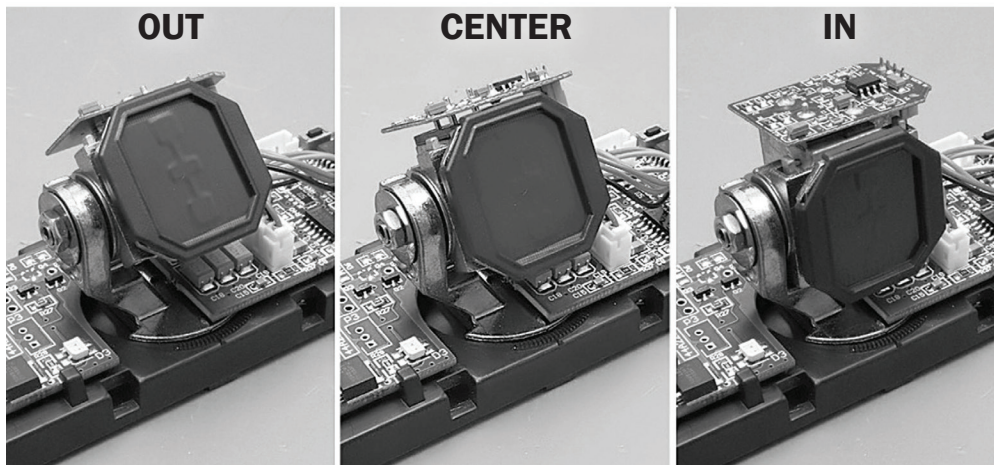

**Adjust the head OUT to IN**

**(H) Move RIGHT, LEFT, OUT or IN for Pattern Location**

**Installation Mode:** To quickly adjust the pattern, press the Reset button and then press & hold the Install button 3 seconds (the LED will flash orange to confirm). This puts the microStar into the install mode allowing the installer to walk test the pattern from several different directions without activating the door. Simply watch the LED while approaching the pattern Green = No detection; Red = Detection. Once the desired pattern is achieved press the reset button and the microStar will reset to normal operating mode.



**NOTE:** Pattern is the same with or without the cover being installed.

**SENSOR SETTINGS AND ADJUSTMENTS (continued)**

**NOTE:** Walk testing the microStar can also be done while the unit is in normal operating mode; the Install Mode is an optional time savings feature.

- Replace the cover by engaging the left side first and then gently snapping the cover into place as shown **(I)**.

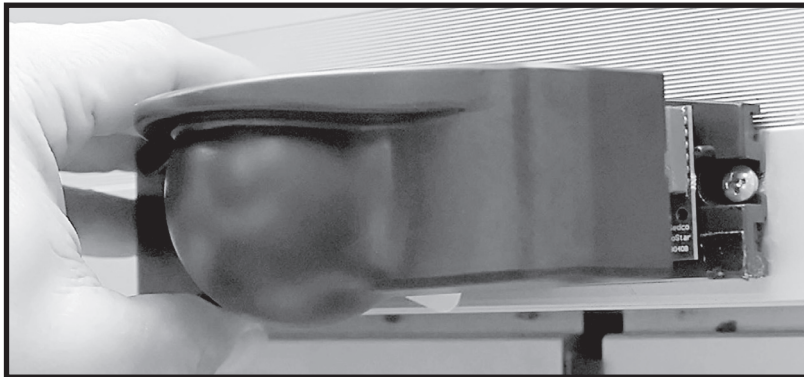

**(I) Attach Cover**

**NOTE:** Repeat walk test. If pattern size changes are desired remove the cover from the right side and make the necessary adjustments.

**OPTIONAL ACCESSORIES**

**MS-BDB Mounting Bracket**

The MS-BDB is an optional mounting device that allows the installer to elevate and rotate the microStar-M for special configurations.

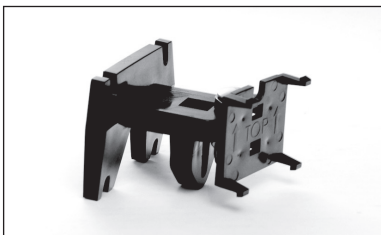

**MSRC Rain Cover**

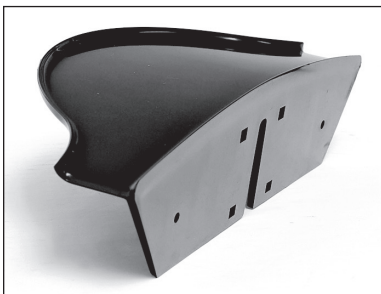

**DIMENSIONS**

